

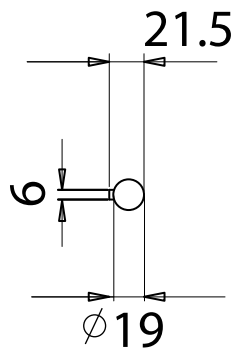

VACUUM PUMPS

DOUBLE STAGE LIQUID RING VACUUM PUMP D32 SERIES

Bareshaft Pump Construction

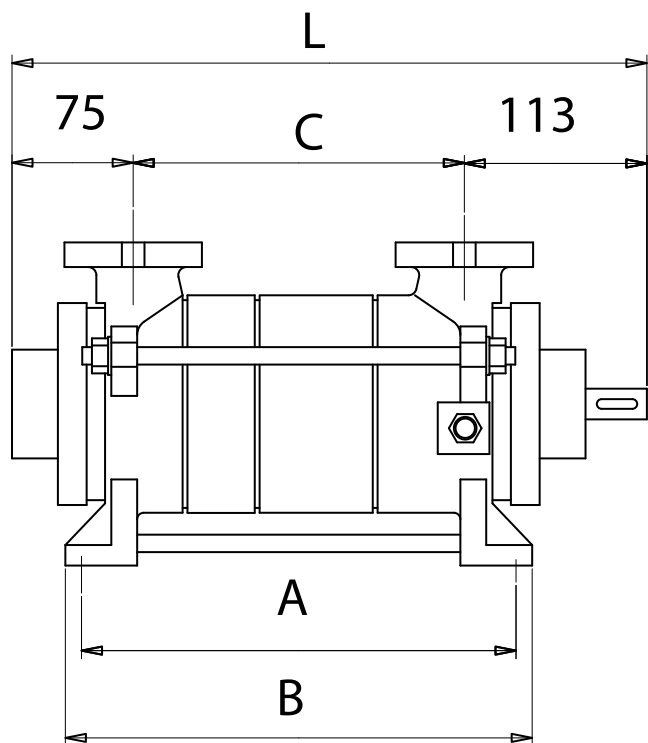

Liquid Supply Inlet
3/8" NPT

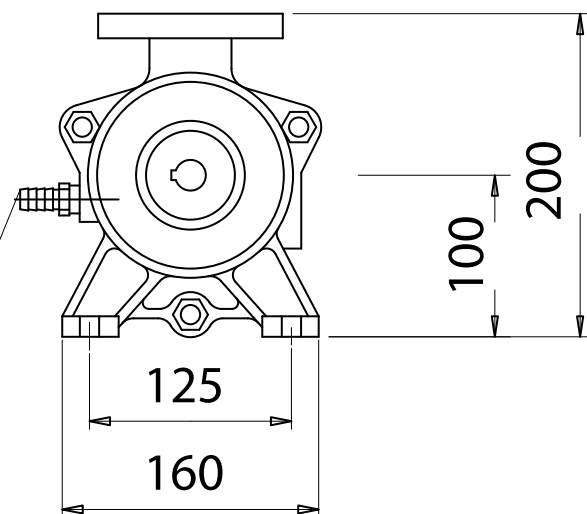

COMPANION FLANGE

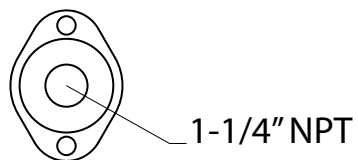

Pump Model	A	B	C	L
D32-20	193	219	139	327
D32-45	243	269	189	377